

**2 CM x 2 CM
SQUARE**

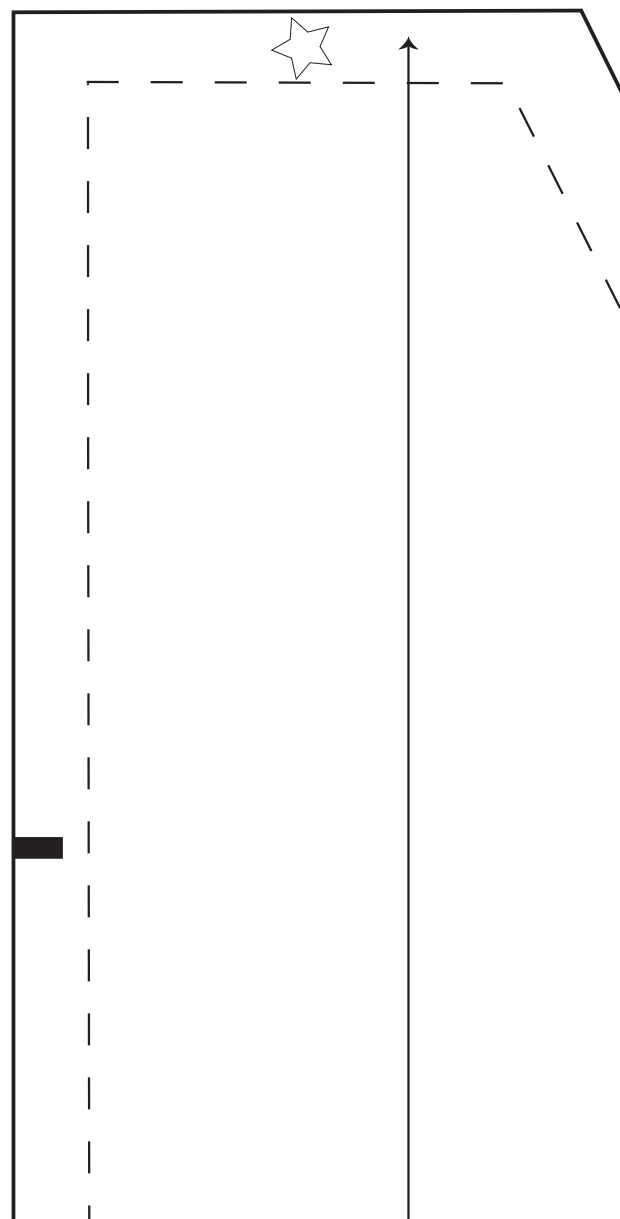

side pannel match-point

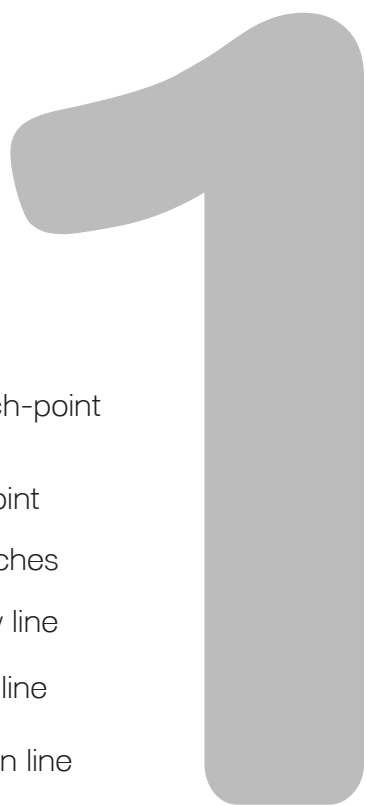

buckle match-point



notches



sew line



cut line



grain line

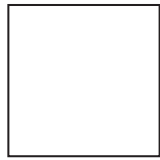

2 CM x 2 CM
SQUARE

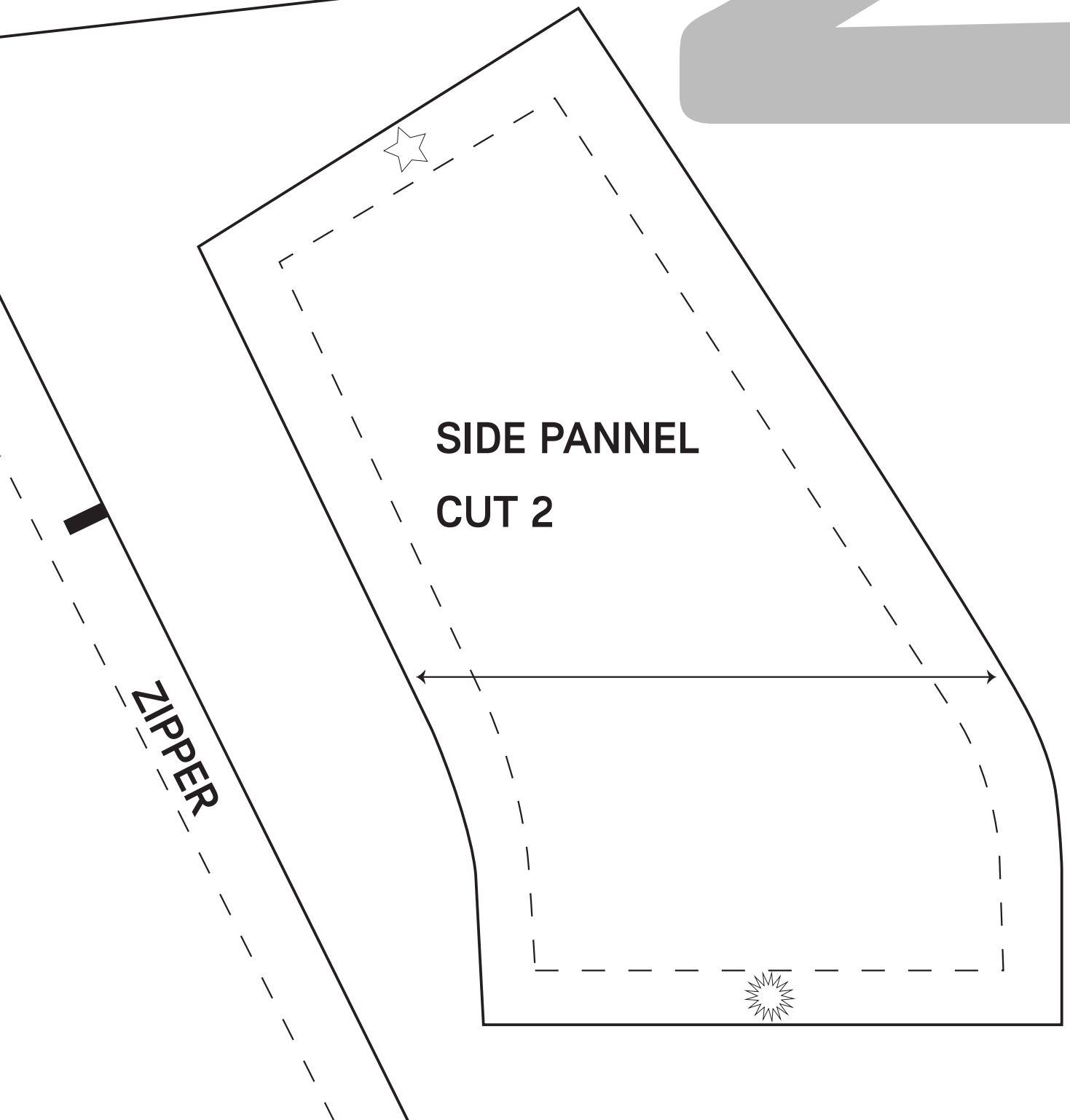
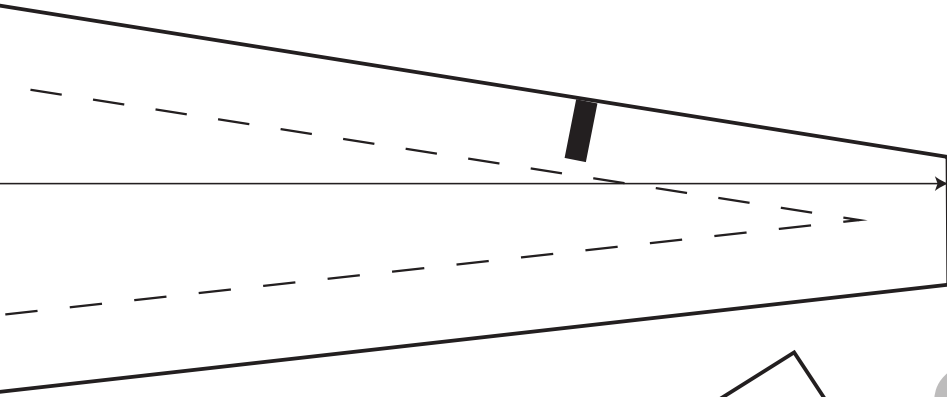
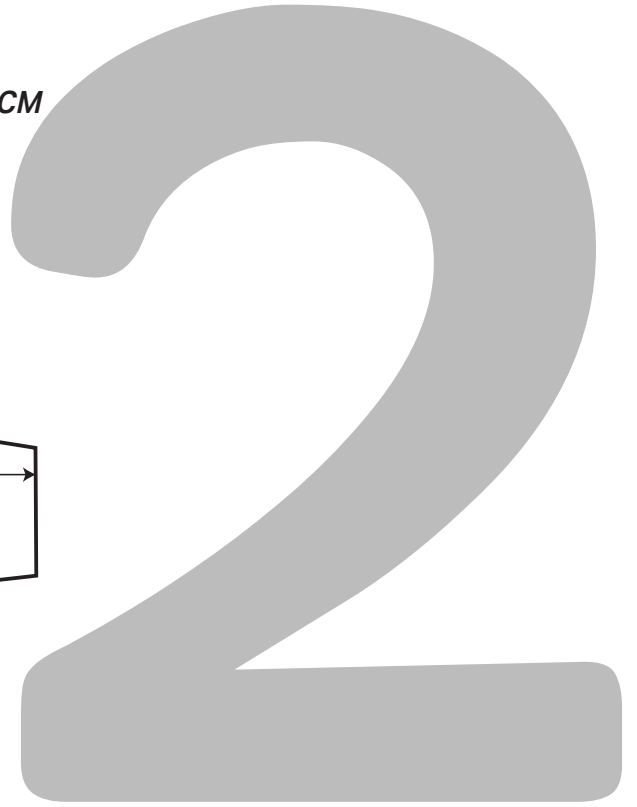

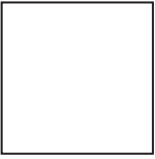
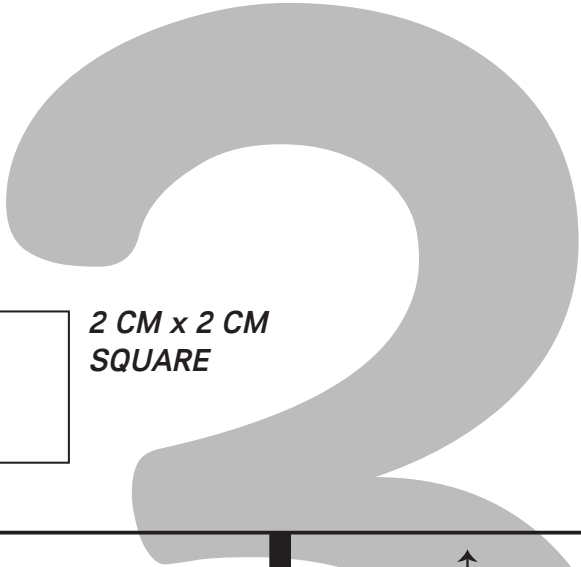

*2 CM x 2 CM
SQUARE*

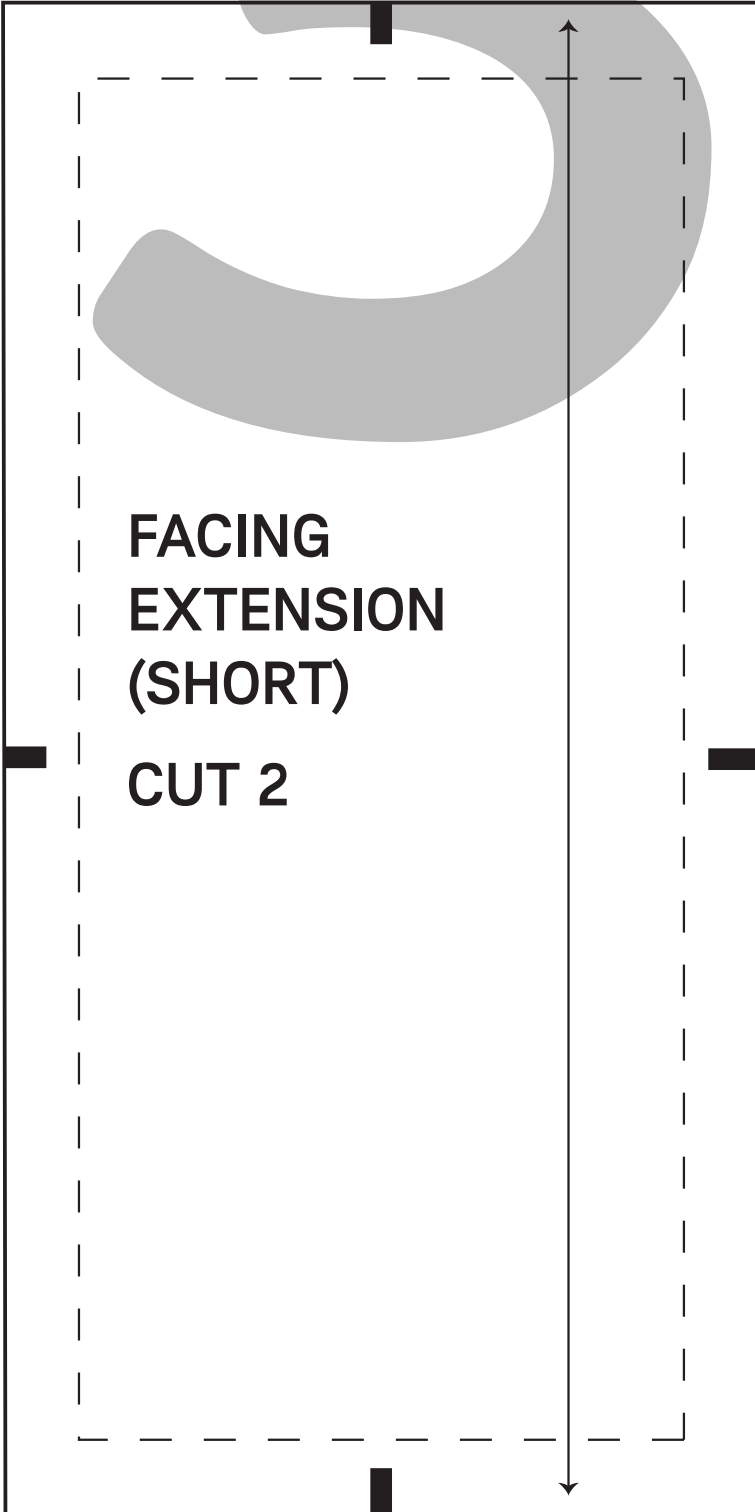

**FACING
EXTENSION
(SHORT)**

CUT 2

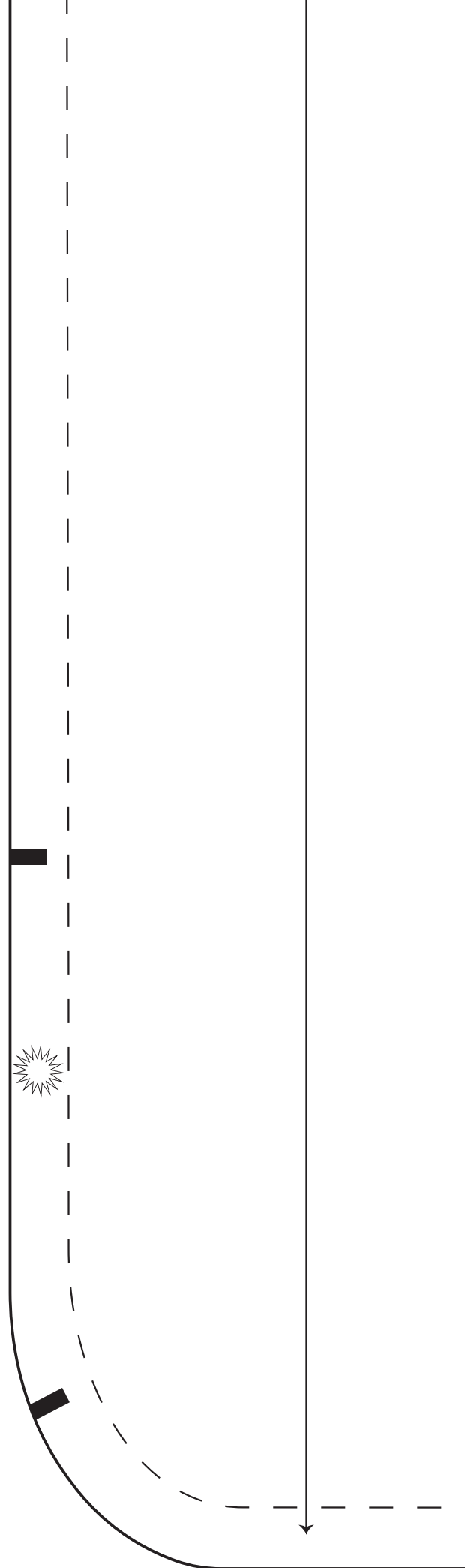

MAIN BODY

CUT 4

(2 FRONT/2 BACK)

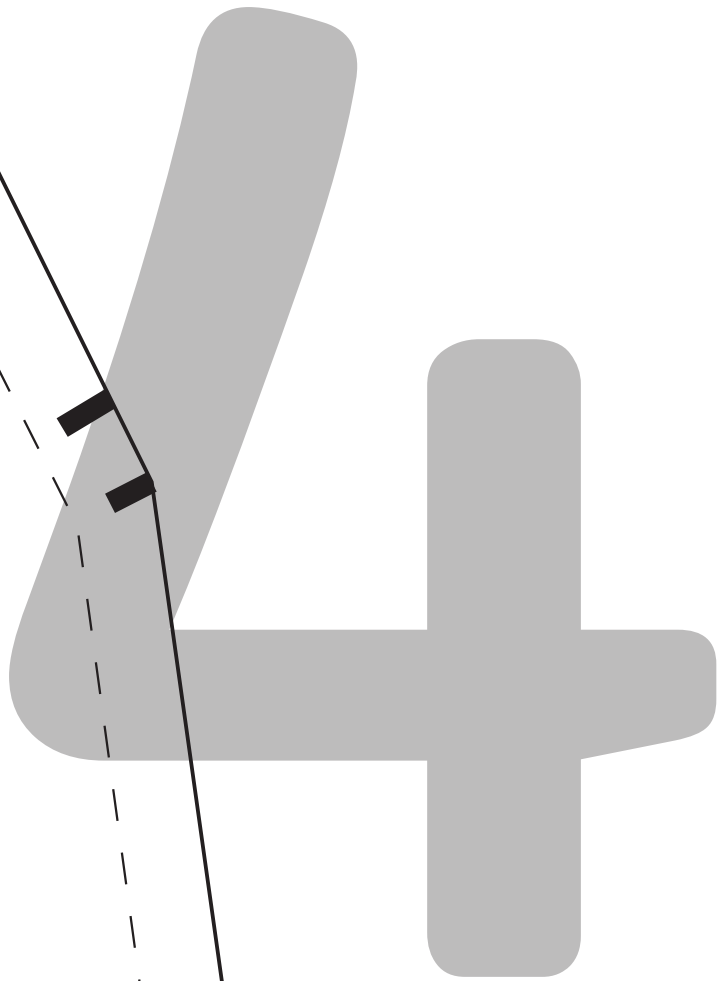

**2 CM x 2 CM
SQUARE**

**FACING
EXTENSION
(LONG)**

CUT 2

**RIGHT SIDE UP
(RSU)**

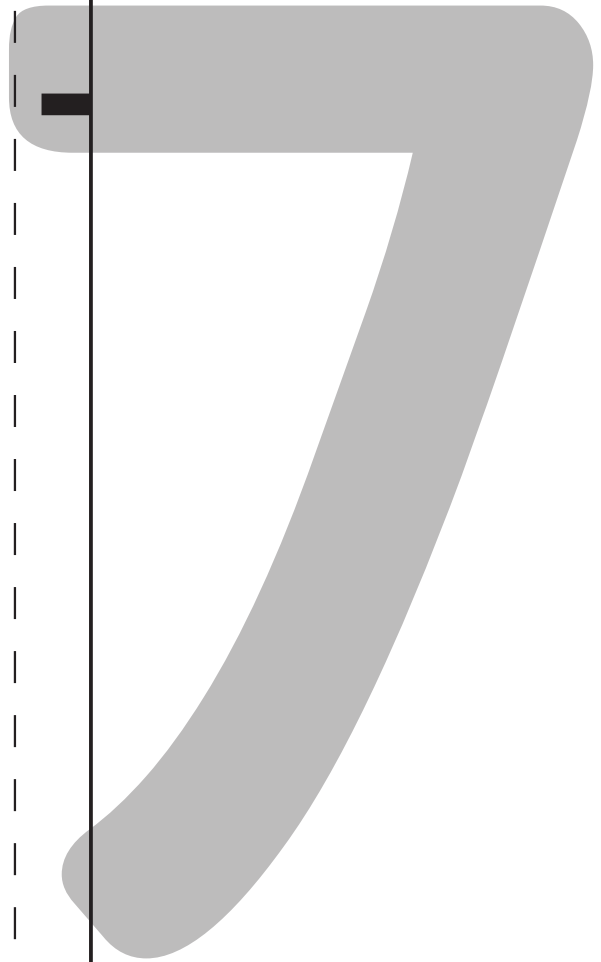

**2 CM x 2 CM
SQUARE**

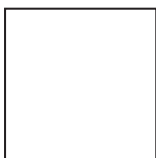
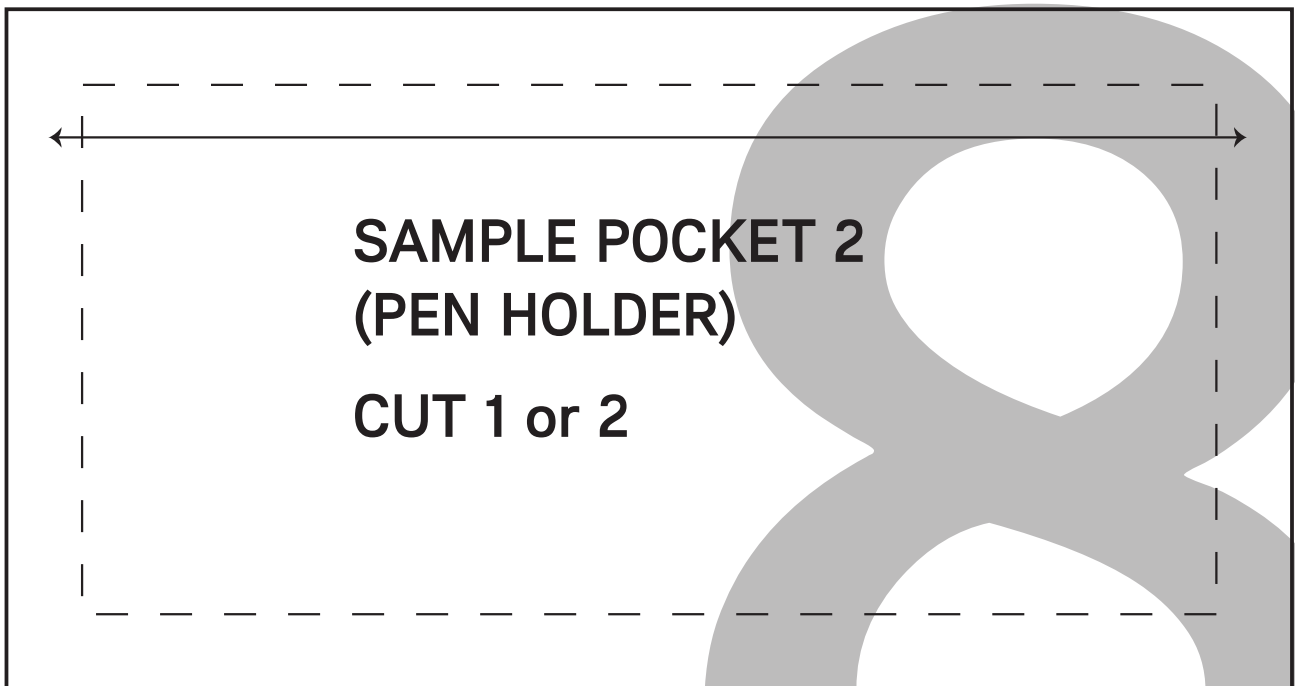
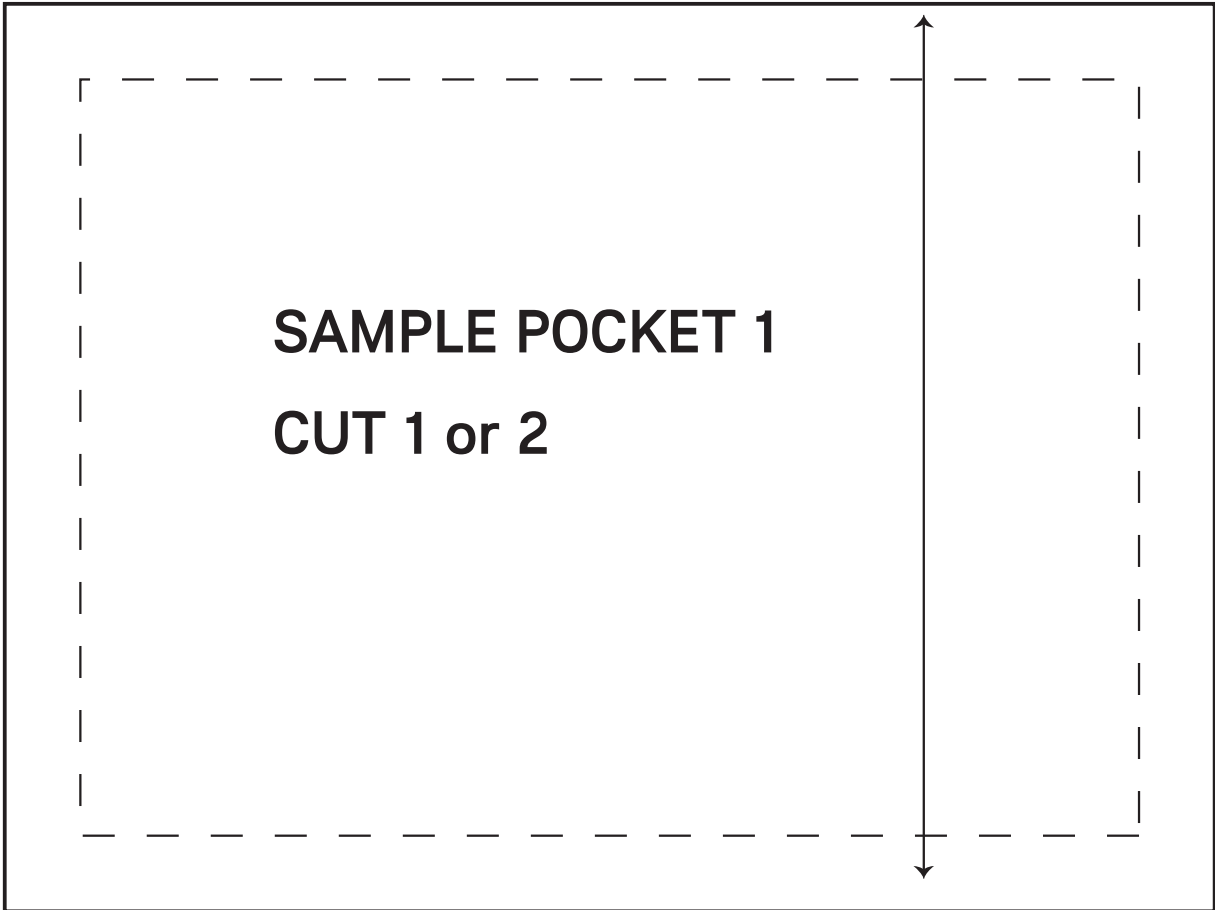

2 CM x 2 CM
SQUARE

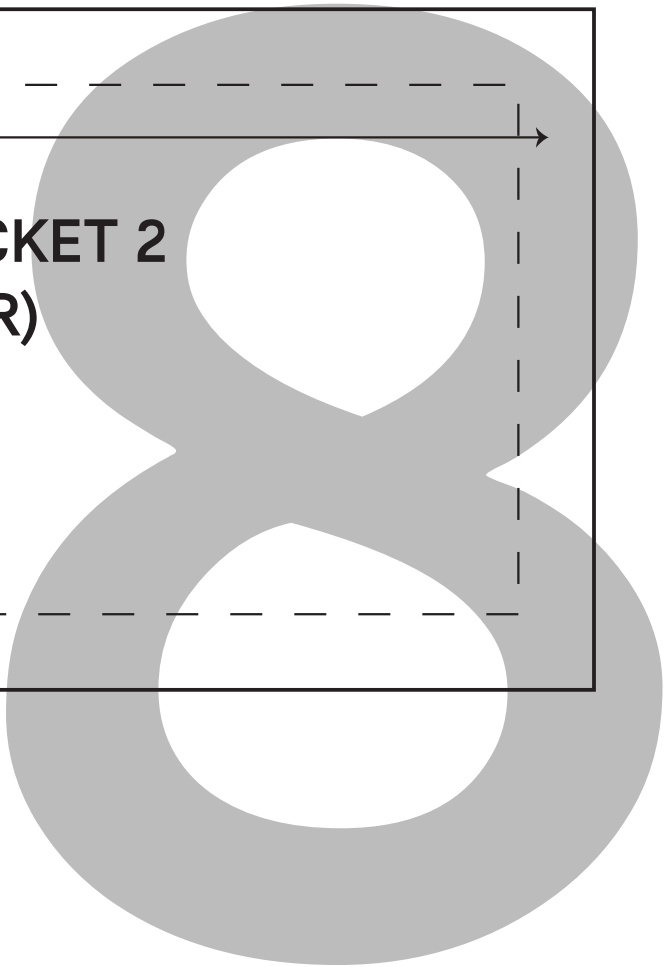

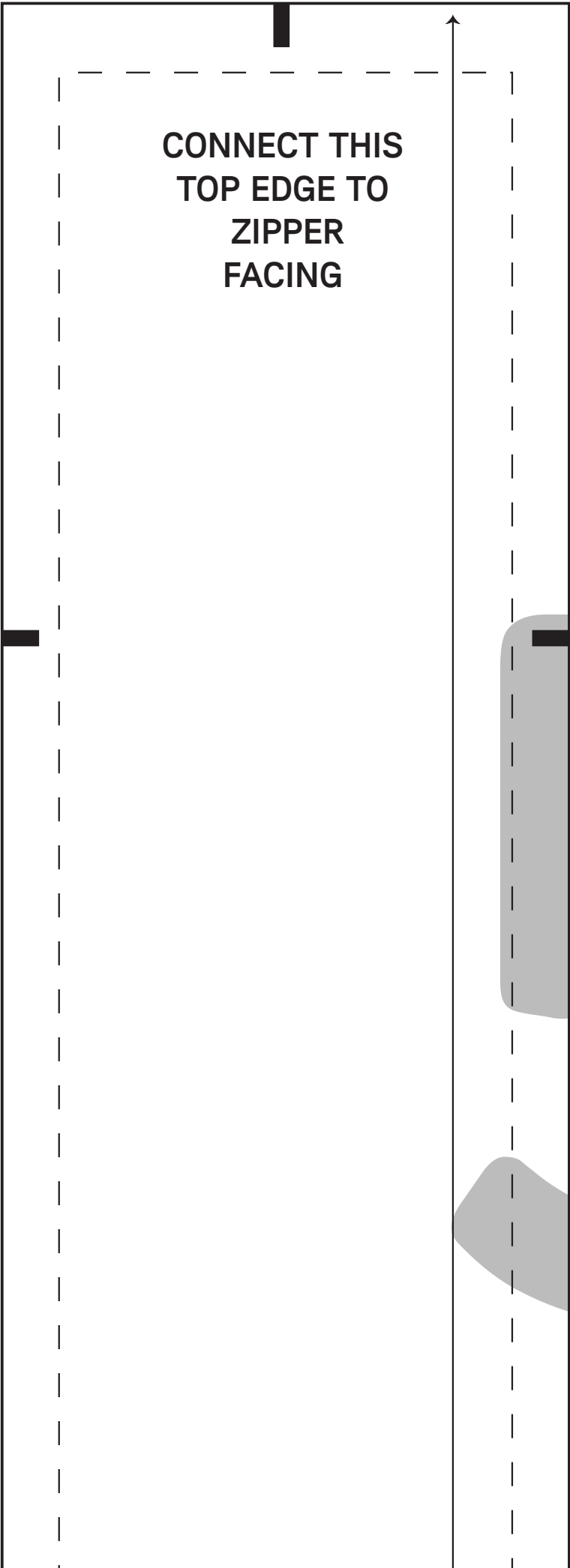

**CONNECT THIS
TOP EDGE TO
ZIPPER
FACING**

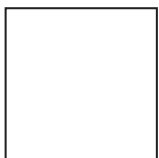
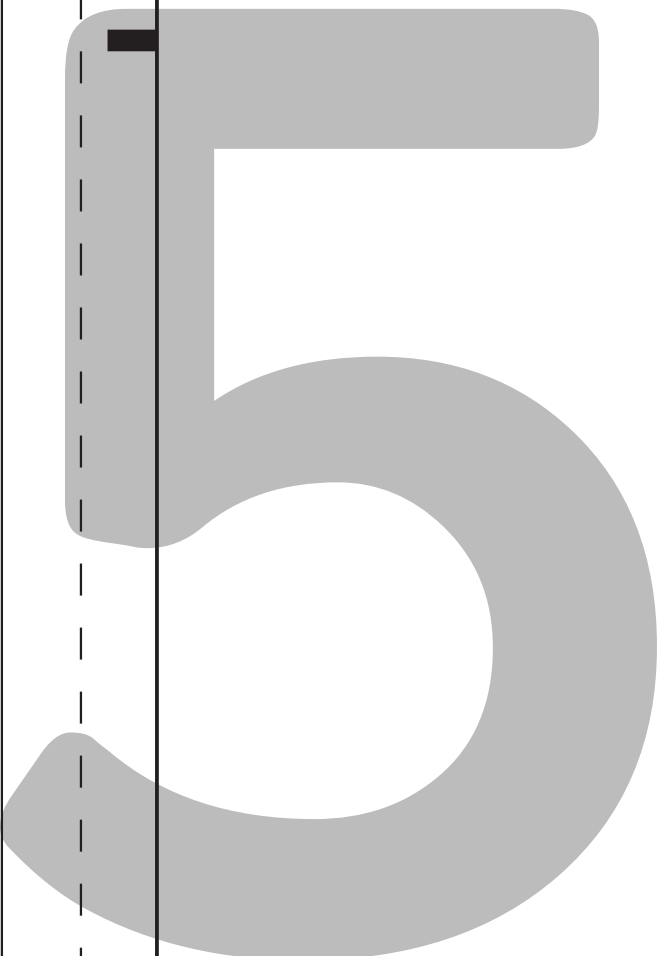

**2 CM x 2 CM
SQUARE**

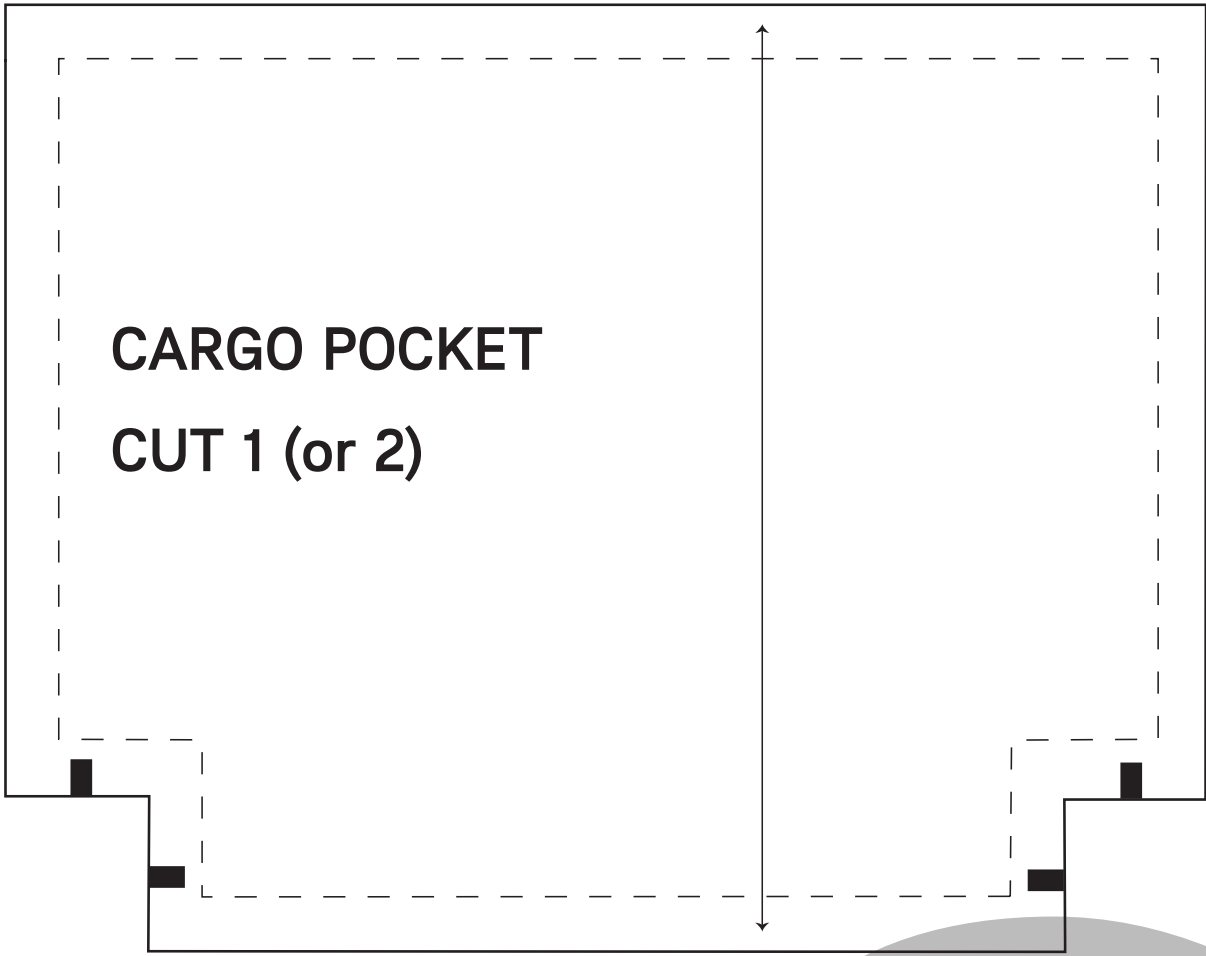

CARGO POCKET
CUT 1 (or 2)

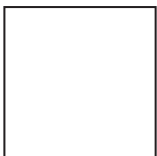

2 CM x 2 CM
SQUARE